

Owner's Guide 0300181-06 Rev.H

SLC 500™ 50 KHz COUNTER / FLOWMETER INPUT MODULE

Catalog Numbers

1746sc-CTR4

1746sc-CTR8



Important Notes

1. Please read all the information in this owner's guide before installing the product.
2. The information in this owner's guide applies to hardware and firmware version 1.0 or later.
3. This guide assumes that the reader has a full working knowledge of the relevant processor.

Notice

The products and services described in this owner's guide are useful in a wide variety of applications. Therefore, the user and others responsible for applying the products and services described herein are responsible for determining their acceptability for each application. While efforts have been made to provide accurate information within this owner's guide, Spectrum Controls assumes no responsibility for the accuracy, completeness, or usefulness of the information herein.

Under no circumstances will Spectrum Controls be responsible or liable for any damages or losses, including indirect or consequential damages or losses, arising out of either the use of any information within this owner's guide or the use of any product or service referenced herein.

No patent liability is assumed by Spectrum Controls with respect to the use of any of the information, products, circuits, programming, or services referenced herein.

The information in this owner's guide is subject to change without notice.

Limited Warranty

Spectrum Controls warrants that its products are free from defects in material and workmanship under normal use and service, as described in Spectrum Controls literature covering this product, for a period of 1 year. The obligations of Spectrum Controls under this warranty are limited to replacing or repairing, at its option, at its factory or facility, any product which shall, in the applicable period after shipment, be returned to the Spectrum Controls facility, transportation charges prepaid, and which after examination is determined, to the satisfaction of Spectrum Controls, to be thus defective.

This warranty shall not apply to any such equipment which shall have been repaired or altered except by Spectrum Controls or which shall have been subject to misuse, neglect, or accident. In no case shall the liability of Spectrum Controls exceed the purchase price. The aforementioned provisions do not extend the original warranty period of any product which has either been repaired or replaced by Spectrum Controls.

Contents

Overview And Specifications	7
General Features And Benefits	7
Detailed Specifications	9
Table 1.1. Electrical specifications—module	9
Table 1.2. Physical specifications	10
Table 1.3. Environmental specifications	10
Installing And Wiring Your Module	11
Avoiding Electrostatic Damage	12
Determining Power Requirements	12
Table 2.1. Backplane current consumed	13
Selecting a Rack Slot	13
Setting your Jumpers	13
Inserting Your Module Into The Rack	14
Wiring Your Module	15
Terminal Block Wiring	17
Labeling And Re-Installing The Terminal Block (if it is removed)	18
Things To Consider Before Using Your Module	19
Module ID Code	19
Table 3.1 Module ID codes	19
Module Addressing	20
Figure 3.1	20
Operating Modes	22
Table 3.2 Module operating modes	22
Input Configurations	22
Gate Modes	24
Channel Turn-On, Turn-Off, and Reconfiguration Times	24
Response to Slot Disabling	24
Channel Configuration, Data, and Status	27
Configuring Each Input Channel	27
Output Register - Scale and Limit Data Values	34
Input Registers - Channel Data	37

Check each output channel's configuration and status	39
Programming / Application Examples	43
Sample Counter Configuration	
Simple Linear Counter	
(10,000 Limit):	43
Ring Counter Sample	44
Sample Configuration	
Simple Ring Counter	
w/ Flags (20k Limit):	45
Using Preset Values	
with Extended Mode	46
Using Scaling with	
Count and Rate Outputs:	46
Application:	
Meter Proving	47
Application Note:	
Factor Data Errors	48
 Testing Your Module	 51
Inspecting Your Module	51
Disconnecting Prime Movers	52
Powering Up	52
Interpreting The LED Indicators	53
Figure 6.1. LED block	53
Operation	53
Table 6.1 Channel Status LED Blink Codes	53
Codes	54
No Signal	54
Troubleshooting	55
Figure 6.2. Problem resolution flowchart	55
 Maintaining Your Module	
And Ensuring Safety	57
Preventive Maintenance	57
Safety Considerations	57
Declaration of Conformity	59

Overview And Specifications

The 1746sc-CTR4 and the 1746sc-CTR8 are 4 and 8 channel Counter/Flow Meter modules. The modules are suitable for general purpose counter and flow meter applications that require a large number of input channels and high accuracy. The module supports both AC and DC input signal types. The counter functions include programmable control of the counter including start, stop, reset, preset control and user defined flags. The input levels for the counter mode are 5, 12, and 24 volts DC. The Flow Meter mode is compatible with variable reluctance AC input. This differential AC input will count AC zero crossing signals from 50 mV to 75 V peak.

Read this chapter to familiarize yourself with your counter module. This chapter covers:

- General features and benefits
- Detailed specifications

General Features And Benefits

- 8 Input Channels or 4 Channels of Quadrature Encoders
- 4 External Counter enable inputs
- Input voltage ranges: AC (50mv–75V peak), 5 Vdc, 12 Vdc, 24 Vdc
- Input frequency: AC 50 KHz Max, DC 50 KHz Max
- Maximum count value: ± 32 K or ± 8 M
- Programmable Scaling, K, M, R Factor
- Channel update time of 4 msec/channel
- Rate output mode (Integrer and Floating Point)
- Counter logic level state
- Programmable Counter functions: start/stop/reset/present
- Programmable counter Alarm flags and zero flags
- 3 Selectable filters: 15 KHz, 30 KHz, 50 KHz
- Channel to back Plane isolation of 1000 Vdc

Increased Accuracy and Reliability

The counter module offers ± 1 count accuracy and $\pm 1\%$ or better frequency measurement accuracy. Programmable functions allow the user to define counter ranges and flags to accommodate process-specific requirements. Full speed counter operation of over 50kHz is possible.

Reduced System Costs

High Channel density allows for lower resource usage. Eight channels consume the resources associated with a standard two channel module.

State-of-the-Art Performance

These modules incorporate state of the art Programmable Gate Array technology that allows high circuit density and functionality. The module uses proprietary Allen-Bradley technology, so they operate and perform like the latest Allen-Bradley products. They also provide high resolution, user-programmable range settings, continuous temperature compensation (no field calibration), software configuration, programmable output limits, and programmable safe states in case of a fault.

Detailed Specifications

Table 1.1. Electrical specifications—module

Specification	Description
Configuration	4/8 Channel of differential counter inputs 2/4 Channels of quadrature encoding 2/4 Input enable Control lines
Input Modes	DC counter, AC flow meter,
Voltage Range	AC 0-30VP 5VDC 12VDC 24VDC
VIL	-50mV 1V 3V 5
VIH	+50mV 3.5V 9V 13
Vmax (CE)	$\pm 75V$ $\pm 75V$ $\pm 75V$ $\pm 75V$
Vmax (UL)	$\pm 100V$ $\pm 100V$ $\pm 100V$ $\pm 100V$
Current Range	5mA Max @ 120V
Input Impedance	Rin > 10 MOhm when within -10V to +12V range Rin = 25kOhm when outside of -10V to +12V range Cin 100pF Input Filter Off Cin 1000pF Input Filter On
Counter Speed	DC Inputs 0 Hz to 50kHz AC Inputs 0 Hz to 50kHz
Input Frequency	DC Inputs 1 Hz to 50kHz AC Inputs 1 Hz to 50kHz
Counter Enable Input	VIL 1.0V max VIH 3.5V min

Vmax	75V
Input impedance	25K ohms
Input Filter	
Digital Filter	50kHz (Default)
Digital Filter	30kHz
Analog Filter	15kHz
<hr/>	
Min Pulse Time	
DC mode	8us
External Enable/Disable	Enable and Disable setup time = 20us
<hr/>	
Channel Update Time	
Counter Output	Scaling OFF ON
	4.0 5.6 (msec per channel)
Rate Output	
Rate Instantaneous Mode	4.0 5.6 (msec per channel)
Rate Average Mode	1.0 1.0 (sec per channel)
<hr/>	
Accuracy	
Count mode	± 1 Count
Rate (Instant)	± 1% @ 50KHz, .001% @ 1Hz
Rate (Average)	± 1Hz
<hr/>	
Maximum Count Value	
	Low Range -32,768 to +32,767
	High Range -8,388,608 to +8,388,607
<hr/>	
Fault detection	Over & under range status bits, for all modes.
<hr/>	

Data Format

Counter mode	Max Binary Value: -8,388,608 to +8,388,607
Rate mode	Max Binary Value: -32,768 to +32,767

Isolation

Channel to Rack	1000 VDC Continuous	Optical & magnetic
Channel to Channel	0VDC	

Input Protection

Max input voltage ± 100 VDC, 150VAC peak
Max input current ± 5 mA@100Vp

Power Requirements

	CTR4	CTR8
Internal rack +5v	175mA	225mA
Internal rack +24V	75mA	125mA

Table 1.2. Physical specifications**LED Indicators**

Module Status	The Module Status LED indicates the status of the power up self test. The LED is on when the module is ready. Any self test error is indicated with a blink code.
Channel Status	CTR4 - 4 Green LEDs CTR8 - 8 Green LEDs The 8 Channel LED's indicates that a channel is enabled.

Terminal Block

24 pin removable connector

Wire Size

One 12 AWG to 28 AWG wires

Torque

.5nm, 4.5 lb.in.

Table 1.3. Environmental specifications**Temperature / Humidity****Ranges**

Operating Temperature	0-60degC (32-140F)
Storage Temperature	-40 to +85degC (-40 to + 185F)
Humidity Temperature	5% to 95% non-condensing
Certifications	UL508 CUL& Class 1, Div II, (CSA equiv.) FCC Part 15 class A CE Compliance to EN 61010-1 and EN 61131-2, EN50081-2, EN50082-2.

Installing And Wiring Your Module

Read this chapter to install and wire your module. This chapter covers:

- avoiding electrostatic damage
- determining power requirements
- selecting a rack slot
- inserting your module into the rack
- wiring your module

Important - For UL and CUL compliance, power and input/output (I/O) wiring must be in accordance with Class I, Division 2, wiring methods [Article 501-4 (b) of the National Electrical Code , NFPA 70] and in accordance with the authority having jurisdiction. Also, you must observe the warnings shown below. Failure to observe these warnings can cause personal injury.

WARNING

EXPLOSION HAZARD



Substitution of components may impair suitability for Class I, Division 2;

When in hazardous locations, turn off power before replacing or wiring modules;

Do not disconnect equipment unless power has been switched off or the area is known to be non-hazardous.

The following documents contain information that may help you as you install and wire your module:

- *National Electrical Code*, published by the National Fire Protection Association of Boston, MA
- *IEEE Standard 518-1977, Guide for the Installation of Electrical Equipment to Minimize Electrical Noise Inputs to Controllers from External Sources*
- *IEEE Standard 142-1982, Recommended Practices for Grounding of Industrial and Commercial Power Systems*
- *Noise Reduction Techniques in Electronic Systems*, by Henry W. Ott; published by Wiley-Interscience of New York in 1976

Avoiding Electrostatic Damage

Guard against electrostatic damage by observing the following precautions:



CAUTION

ELECTROSTATICALLY SENSITIVE COMPONENTS

- Before handling the module, touch a grounded object to rid yourself of electrostatic charge.
- When handling the module, wear an approved wrist strap grounding device.
- Handle the module from the front, away from the backplane connector. Do not touch backplane connector pins.
- Keep the module in its static-shield container when not in use or during shipment.

Failure to observe these precautions can degrade the module's performance or cause permanent damage.

Determining Power Requirements

The backplane of the system can provide both 5 Vdc and 24 Vdc power. The following table shows the maximum current consumed by your module when using these power sources:

Table 2.1. Backplane current consumed

Catalog Number	5 Vdc	24 Vdc
1756sc-CTR8	230 mA	75 mA

Use Table 2.1 to calculate the total load on the system power supply. For more information, see the Allen-Bradley system *Installation and Operation Manual*.

Selecting a Rack Slot

Two factors determine where you should install your module in the rack: ambient temperature and electrical noise. When selecting a slot for your module, try to position your module:

- in a rack close to the bottom of the enclosure (where the air is cooler)
- away from modules that generate significant heat, such as 32-point input/output modules
- in a slot away from ac or high-voltage dc modules, hard contact switches, relays, and ac motor drives
- away from the rack power supply (if using a modular system)

Remember that in a modular system, the processor always occupies the first slot of the rack.

**CAUTION****POSSIBLE EQUIPMENT OPERATION**

Before installing or removing your module, always disconnect power from the SLC 500 system and from any other source to the module (in other words, don't "hot swap" your module), and disconnect any devices wired to the module.

Failure to observe this precaution can cause unintended equipment operation and damage.

When inserting your module into the rack, you do not need to remove the supplied 36-position terminal block from the module. If, however, you do remove the terminal block, use the write-on label to identify your module's location.

To remove the terminal block, unscrew the two retaining screws at the top and bottom of the terminal block, and using a screwdriver or needle-nose pliers, carefully pry the terminal block loose.

To insert your module into the rack, follow these steps:

1. Align the circuit board of your module with the card guides at the top and bottom of the chassis.

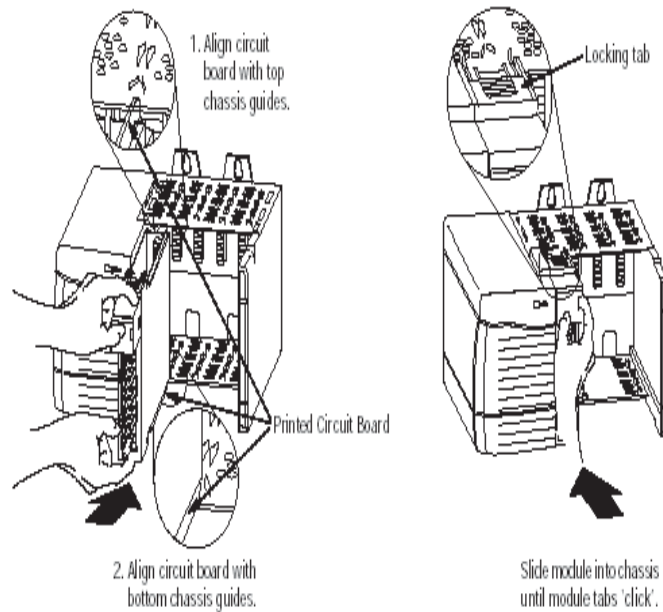

2. Slide your module into the chassis until both top and bottom retaining clips are secure. Apply firm even pressure on your module to attach it to its backplane connector. Never force your module into the slot.

Cover all unused slots with the Card Slot Filler, Allen-Bradley part number 1746-N2.

To remove your module, press the retaining clips at the top and bottom of your module and slide it out.

Wiring Your Module

To wire the terminal block, you need:

- a small, flat-blade screwdriver
- Belden 8761 (shielded, twisted pair) cable or equivalent



CAUTION

POSSIBLE EQUIPMENT OPERATION

Before wiring your module, always disconnect power from the SLC 500 system and from any other source to the module.

Failure to observe this precaution can cause unintended equipment operation and damage.

Before wiring the terminal block, take some time to plan your system:

- Ensure that the SLC 500 system is installed in a NEMA-rated enclosure and that the SLC 500 system is properly grounded.
- Route the field wiring away from any other wiring and as far as possible from sources of electrical noise, such as motors, transformers, contactors, and ac devices. As a general rule, allow at least 6 in. (about 15.2 cm) of separation for every 120 Vac of power.
- Routing the field wiring in grounded conduit can reduce electrical noise further.
- If the field wiring must cross ac or power cables, ensure that they cross at right angles.

To wire your module, follow these steps:

1. Determine the length of cable you need to connect a channel to its field device. Remember to include additional cable to route the drain wire and

foil shield to their ground points. Connect only one end of the shield to the module.

2. At each end of the cable, strip some casing to expose the individual wires.
3. Trim the exposed signal wires to 2 in. lengths. Strip about 3/16 in. (about 5 mm) of insulation away to expose the end of each wire.
4. At one end of the cable, twist the drain wire and foil shield together, bend them away from the cable, and apply shrink wrap.

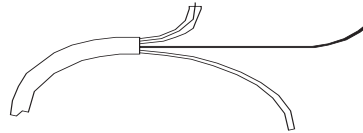

5. At the other end of the cable, cut the drain wire and foil shield back to the cable and apply shrink wrap.

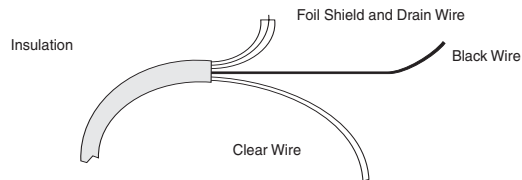

6. Connect the wires to the terminal block and field device as shown in the following figures and table. The recommended maximum torque is 4.5 in-lb (0.565 Nm) for all terminal screws.

To guard against electrostatic damage and improve chassis grounding, connect one of the shield pins on the terminal block of your module to the chassis itself.

7. Repeat steps 1 through 6 for each channel on your module.

A system may malfunction due to a change in its operating environment. After installing and wiring your module, check system operation. See the Allen-Bradley system *Installation and Operation Manual* for more information.

Terminal Block Wiring

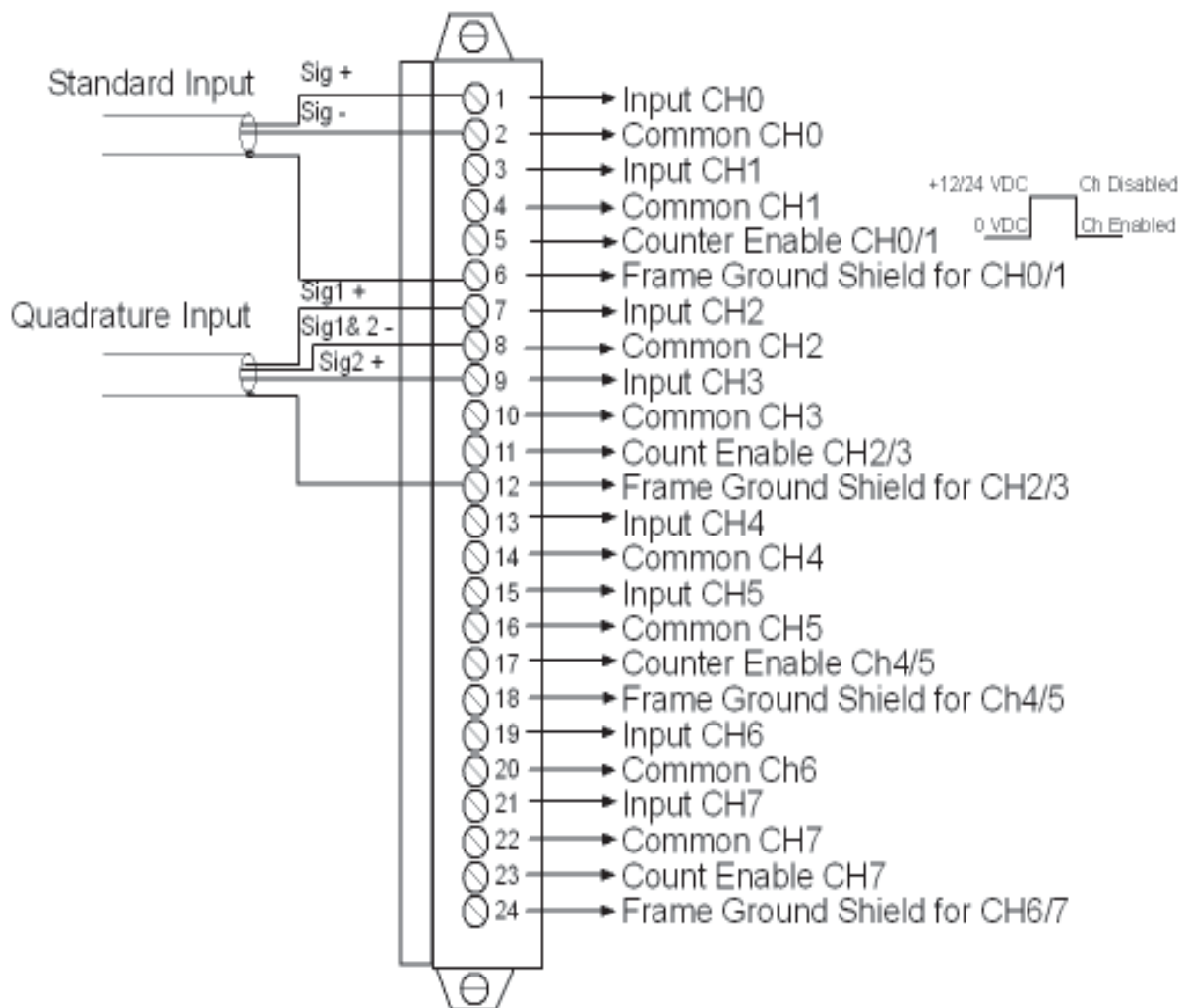

Note: Channels 4-7 are only available on the 1746sc-CTR8 module.

Note: A pull up resistor may be necessary for open collector inputs. Refer to Chapter 6 for additional information.

Labeling And Re-Installing The Terminal Block (if it is removed)

The supplied label is mounted on the module door. This label helps ensure that the terminal block is wired correctly for the module.

Once you have wired your module and properly labeled install the terminal block on your module:

1. Align the terminal block with the receptacle.
2. Insert the terminal block and press firmly at the top and bottom until it is properly seated.
3. Screw in the two retaining screws on the top and bottom of the terminal block.

Things To Consider Before Using Your Module

This chapter explains how the module and the SLC processor communicate through the processor's I/O image tables. It also describes the module's input filter characteristics. Topics discussed include:

- module ID code
- module addressing
- operating modes
- input configurations
- gate modes
- channel turn on / turn off / reconfiguration timing
- response to slot disabling

Module ID Code

Before using your module, you must configure the slot your module is in by entering the module's ID code in APS or RS Logix. Enter your module's ID code, select "other" from the list of modules on the APS or RS Logix system I/O configuration display and enter your module's ID code at the prompt.

The module ID code for your input module is:

Table 3.1 Module ID codes

Catalog Number	Module ID code
1746sc-CTR4	10200
1746sc-CTR8	10401

Module Addressing

The CTR-8 module uses 32 input and 32 output registers, and the CTR-4 module uses 16 input and 16 output registers. Both modules use Class III mode operation and cannot be used with Class I operation. The following memory map shows you how the SLC processor's output and input tables are defined for the module. The SLC 5/01 processor does not support Class III operation and is not compatible with this module. This module is not suitable for use in remote rack applications with ASB modules due to the input / output word size.

Figure 3.1 Image table

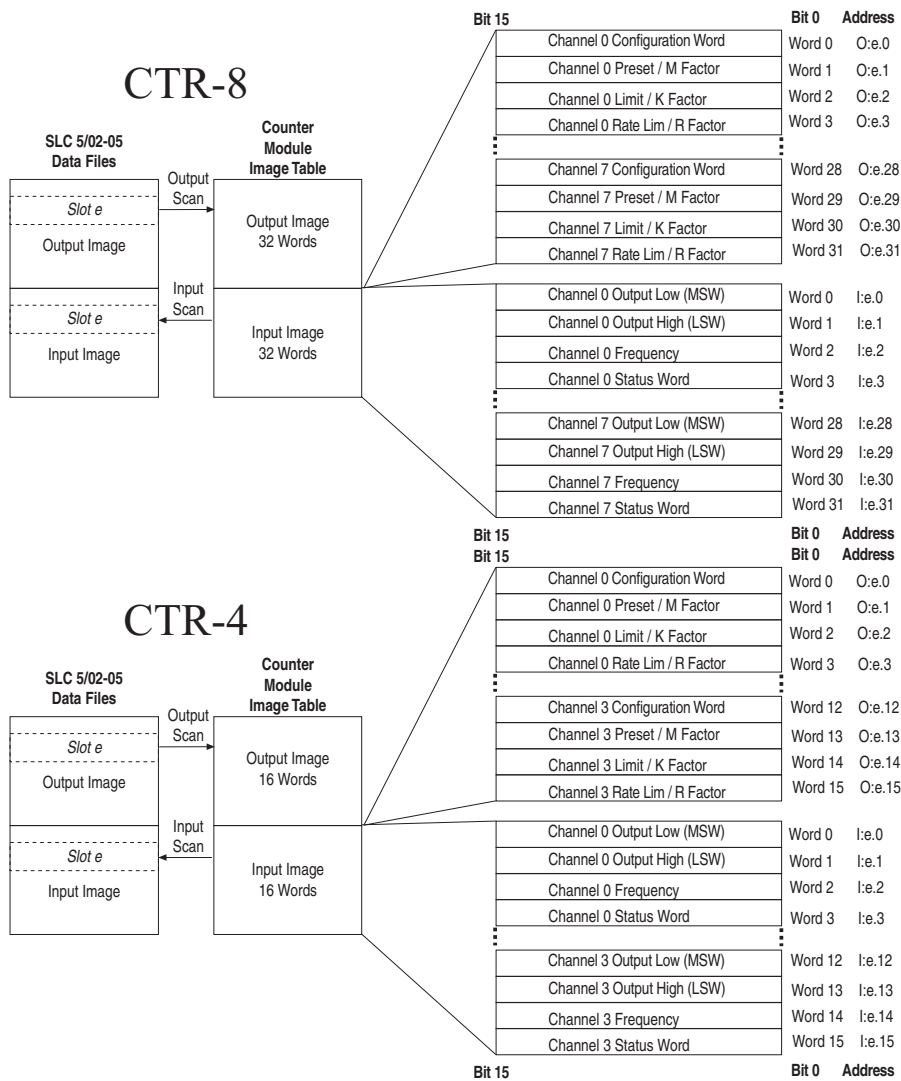

Output Image - Configuration Words

Thirty-two (CTR-8) or sixteen (CTR-4) words of the SLC processor's output image table are reserved for the module. For the CTR8, output image words 0-31 are used to configure input channels 0-7. For the CTR4, output image words 0-15 are used to configure input channels 0-4. Each output image word configures a single channel, sets the preset, limit and scale factors and can be referred to as a configuration word. Each word has a unique address based on the slot number assigned to the module.

Example Address - If you want to configure the second channel on the module located in slot 4 in the SLC chassis, your address would be O:4.4.

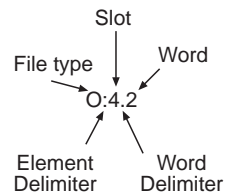

Chapter 4, *Channel Configuration, Data, and Status*, gives you detailed bit information about the data content of the configuration word.

Input Image - Data Words and Status Words

Count data, Rate data, and status are given in four input words for each channel.

Chapter 4, *Channel Configuration, Data, and Status*, gives you detailed bit information about the content of the data word and the status word.

Operating Modes

The module's operating mode determines the number of available counters and which inputs are attached to them. There are two operating modes and their input assignments are summarized in the table below.

Table 3.2 Module operating modes

Operational Mode	CTR8 (CTR4) Input Channel Configuration
Single Ended Input	8 (4) Channels – One per input
Single Ended Up/Down	4 (2) Channels - One Input/ One Direction Discrete
Quadrature Input	4 (2) Channels - Two per input.

Input Configurations

Input configurations determine how the 8 inputs cause the counter to increment or decrement. The four available configurations are:

- Uni-Directional (up)
- Bi-Directional (up and down using two channels)
- X1 Quadrature Encoder
- X4 Quadrature Encoder

See the “Summary of Available Counter Configurations” for the input configurations available for the counters, based on operating mode.

Uni-Directional

With this configuration, the input increments in an upward direction. All 8 channels may be configured in the unidirectional mode. Every clock pulse will increment the counter on the rising edge. Note: The direction of the counter may be inverted by setting the Count Direction bit described in the Configuration chapter.

Bi-Directional

The bidirectional counter requires 2 input channels. In this mode one channel is used as the counter input and the 2nd channel is used to determine the count direction. The counter will increment when the Direction Channel value is 0, and will decrement when the Counter Direction Channel value is 1.

X1 Quadrature Encoder

The quadrature mode requires 2 input channels. When a quadrature encoder is attached to an input channel pair, A and B, the count direction is determined by the phase angle between inputs A and B. If A leads B, the counter increments. If B leads A, the counter decrements. (The counter changes value *only* on one edge of input 1.) The counter increments once per quadrature cycle.

Note: The X1 Quadrature mode provides additional Anti-Jitter circuitry. This distinguishes between a valid quadrature sequence and an invalid sequence due to electrical noise or jitter. Jitter can occur if a quadrature encoder stops rotating right at an input sensor trip point. This can cause additional unwanted clock pulses. The X1 quadrature mode can detect invalid transitions and filter these out.

X4 Quadrature Encoder

Like the X1 quadrature encoder, the count direction is determined by the phase angle between inputs A and B. If A leads B, the counter increments. If B leads A, the counter decrements. However, the counter changes value on the rising and falling edges of inputs A and B. The counter increments four times per quadrature cycle.

Note: In the X4 Quadrature mode, invalid signals are not detected. A broken input wire, jitter or noise on the input can cause additional counts to be registered. The modules response to four possible error conditions are listed below:

Input A is active while input B is stuck high: Module will count down on input A transitions.

Input A is active while input B is stuck low: Module will count down on input A transitions.

Input A is stuck high while input B active: Module will count down on input B transitions.

Input A is stuck low while input B is active: Module will count up on input B transitions.

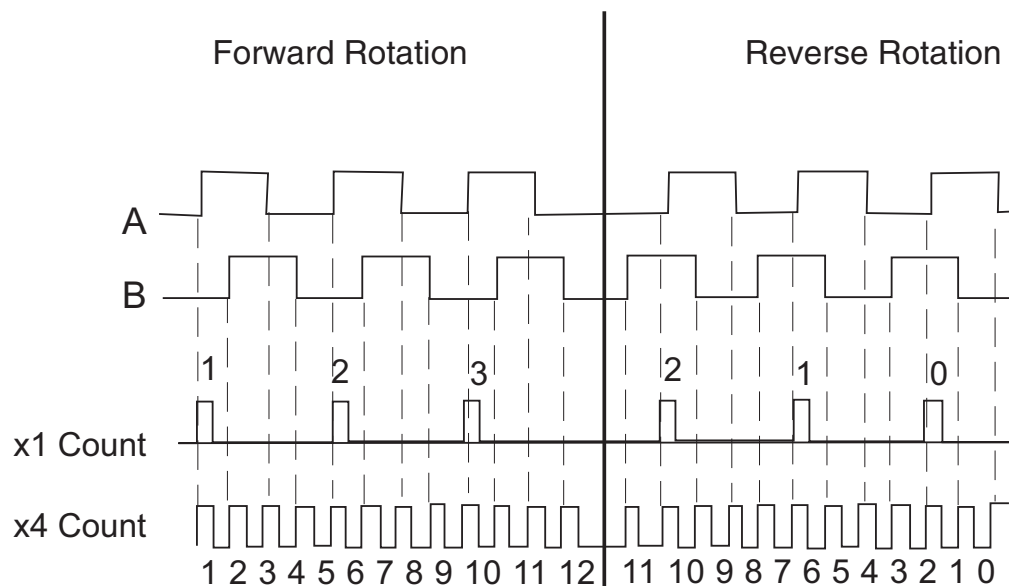
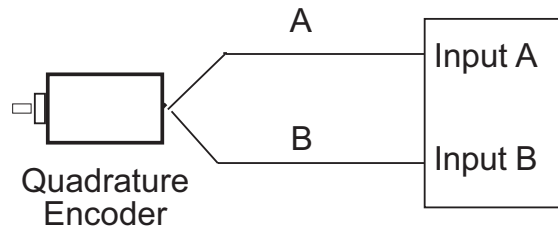

Gate Modes

There are two methods to gate (start/stop) your counter, hardware and software. The counter's gate/preset mode determines what, if any, gating is applied to the counter and what, if any, conditions will preset the counter to the preset value.

External Hardware Gate Lines:

There are four external inputs, one for each pair of input channels, that may be used to start and stop the counter. Each external gate is pulled low internal to the module. A low input allows each pair of counter channels to operate. The count enable line is compatible with 5, 12, and 24 VDC inputs. If pulled high with one of these inputs the pair of counter channels are disabled.

Note: The module's Channel LED's only indicate the state of the counters start/stop bit. They do not indicate that state of the external hardware gate.

Counter Start / Stop Bit

This bit allows the counter to continue to count up or down from its present value. Starting, or enabling this bit will not override the external counter input.

Channel Turn-On, Turn-Off, and Reconfiguration Times

The time required for the module to recognize a new configuration for a channel is one module update time.

Turn-off time requires up to one module update time.

Reconfiguration time is the same as turn-on time.

Response to Slot Disabling

By writing to the status file in the modular SLC processor, you can disable any chassis slot. Refer to your SLC programming manual for the slot disable/enable procedure.



CAUTION

POSSIBLE EQUIPMENT OPERATION

Always understand the implications of disabling a module before using the slot disable feature.

Failure to observe this precaution can cause unintended equipment operation.

Input Response

When a counter slot is disabled, the counter module continues to update its input image table. However, the SLC processor does not read input from a module that is disabled. Therefore, when the processor disables the counter module slot, the module inputs appearing in the processor table is not read. When the processor re-enables the module slot, the current state of the module inputs are read by the processor during the subsequent scan.

Output response

The SLC processor may change the counter module output data (configuration) as it appears in the processor output image. However, this data is not transferred to the counter module. The outputs are held in their last state. When the slot is re-enabled, the data in the processor image is transferred to the counter module.

Channel Configuration, Data, and Status

Read this chapter to:

- configure each input channel
- set user-defined scale limits
- monitor each input channel
- check each output channel's configuration and status

Configuring Each Input Channel

The Data Register format uses Class 3 operation. Class 3 mode allows the module to use 32 input words and 32 output words of data, as listed below. After installing your module, you must configure each channel by setting bit values in each configuration word. Output words 0 through 31 of the output image file (addresses O:e.0 – O:e.31) configure channels 0-7 respectively and (addresses O:e.0 - O:e.15) for channels 0 - 3 of the CTR4.

Figure 4.1 - Configuration Word

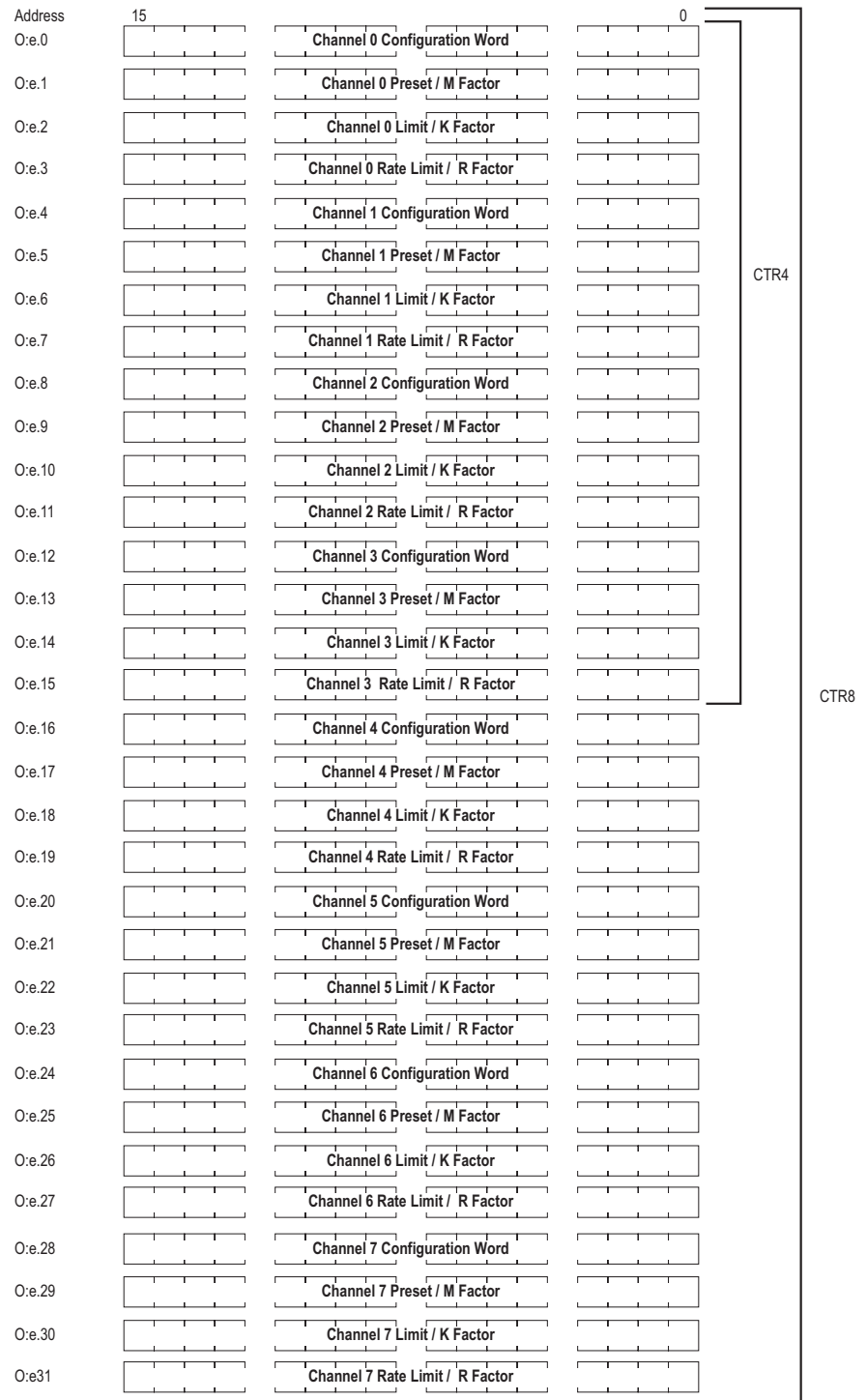
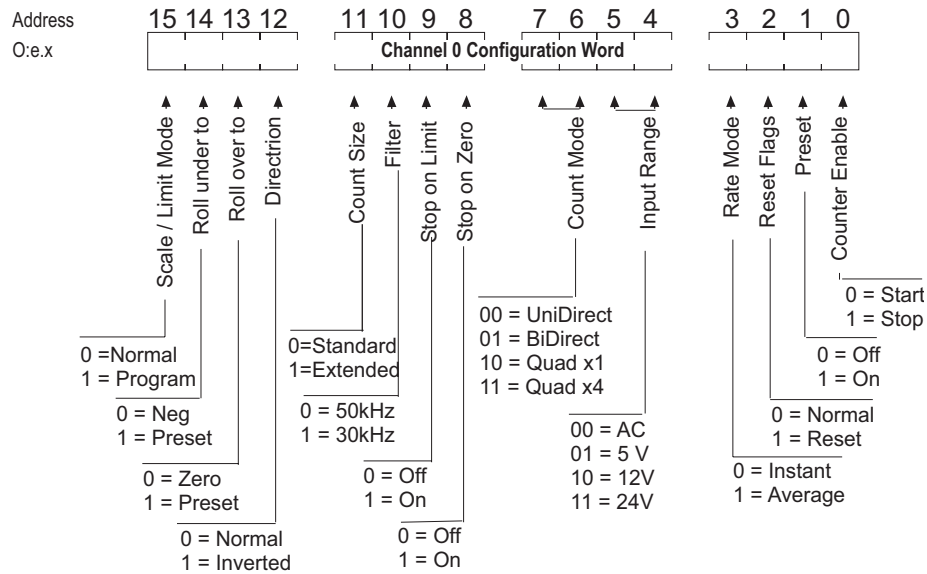

Figure 4.2 - Configuration Word Settings



Counter Start/Stop: (Configuration Bit 0)

This bit allows the counter to continue to count up or down from its present value.

Note: Starting or enabling the counter with this bit will not override the external counter enable input. The external input enable and the counter start bit must both be enabled for the counter to continue counting. If either the counter stop bit or the external input enable line are disabled the counter will hold it's last value and stop counting.

Counter Preset: (Configuration Bit 1)

When this bit is set, the value in counter preset word is loaded into the counter. The counter preset can be used to set the counter to an initial starting value. The bit should be set for at least 2 I/O scans. The bit can be held on until the data in the counter data is verified to be equal to the preset value. The counter will hold the preset value until the counter preset bit is turned off. At this time normal counter functions will resume.

Note: A Counter Reset function is achieved by using the Counter Preset, when the preset value is set to zero.

Refer to the Preset and Limit Data Value Configuration section for more information about loading your preset value.

Reset Flags: (Configuration Bit 2)

The reset flags command is performed when this bit is set. Reset flags affects the counter zero, counter limit and counter maximum flags (Status word bits 8, 6, and 5 respectively.) These particular flags remain high, regardless of the counter behavior, until a reset is performed. This allows adequate time to read the flags after an event has occurred.

If user Counter Limit is set to 0 (0 indicates undefined), these flags will remain high until reset:

Count is equal to zero or counter decremented down through zero flag (Status word bit 8).

Count up or down through the maximum count flag (Status word bit 5).

If a Counter Limit is never set (Status word bit 6) the flags will not announce.

If user Counter Limit is set to a non-zero value (User defined limit), these flags are will remain high until reset:

Count is equal to zero or counter decremented down through zero flag (Status word bit 8).

Count up or down through the limit flag (Status word bit 6).

And these flags do not remain high:

Maximum count flag (Status word bit 5) is set if count value is exactly equal to 32,767 (16 bit) or 8,388,607 (24 bit). Otherwise it is clear.

Rate Mode: (Configuration Bit 3)

Refer to Appendix A for Floating Point Rate Mode

Rate - Average:

When the rate mode bit is set to a “1” the rate detection circuit is in “Rate Average” mode. The rate average mode counts the number of input transitions over a 1 second interval and calculates the input rate averaged over the 1 second interval. The rate average mode is slow, in that it reports updated rates at once per second. However this mode is accurate to ± 1 count over the full range of measurement.

Figure 4.4 - One Second Rate Average



Rate - Instant:

When this bit is reset to “0” the rate detection circuit operates in “Instant” mode. Instant measurements are fast, in that they calculate a rate based on one cycle. However the accuracy of the measurement degrades as the input clock rate goes up to 50KHz, and any jitter within one cycle will be measured.

Figure 4.3 - One Period Rate Measurement

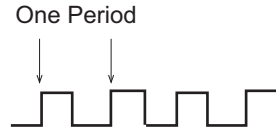

The accuracy while operating in the average mode is ± 1 count. When using the Instant mode the accuracy is $\pm 1\%$ at 50kHz and improves to $\pm 0.002\%$ at 100Hz. The graph below shows the rate accuracy in Hertz vs. Frequency.

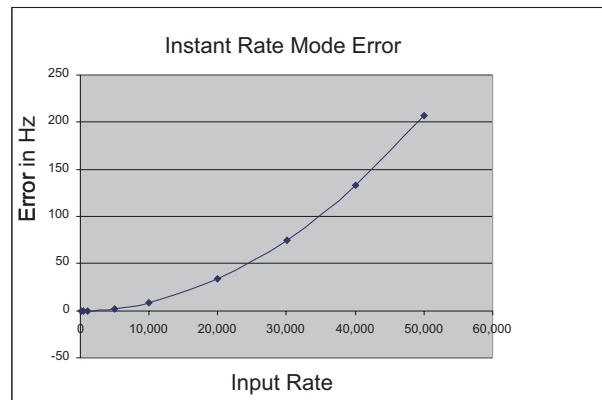
**Input Range: (Configuration Bits 4-5)**

This group of 2 bits selects one of 4 input ranges. Each range is selected for a given system voltage level. Each range has its own counter trip level. Refer to the Specifications section of this manual for input limit information.

Table 4.2 Input Range Selection Bits

Mode	Bit Setting	Range
AC	00	50 mV to 30 VAC
DC	01	0 to 5 VDC
DC	10	0 to 12 VDC
DC	11	0 to 24 VDC

Note: The input range must be configured in channel pairs to operate properly. Pairs are channels 0-1, 2-3, 4-5, 6-7.

Note: You should allow at least 1 scan time for input range information to be updated at the PLC.

Count Mode: (Configuration Bits 6-7)

The Count Mode bit selects 1 of 4 types of counter operation.

The **Unidirectional** counter mode is configured as an Up or Down counter. The module will support 8 unidirectional input channels. Every clock pulse increments the counter.

Note: The direction of the count can be inverted by the COUNT DIRECTION bit (see bit 12).

The **Bidirectional** counter requires 2 channels inputs. In this mode one channel is used as the counter input and the 2nd channel is used to determine the count direction. The counter will increment when the Direction input channel is a 1, and will decrement the counter when the Direction input channel is a 0. Even channels, 0,2,4,6 are inputs. Odd channels, 1,2,5,7 control direction. Both channels within a pair must be configured for bidirectional mode. Bidirectional encoding will report the same count value on each channel's output.

When the counter is set to **Quadrature** mode channels will be configured into quadrature encoding pairs. Both channels within a pair must be configured for quadrature mode. Quadrature encoding will report the same quadrature count value on each channel's output. Quadrature mode allows for the channels to count up or down depending on the quadrature encoding direction. The COUNT DIRECTION bit can invert the direction of the quadrature encoding. The QUAD X1 mode clocks the counter once every quadrature cycle. The QUAD X4 mode clocks the counter 4 times every quadrature cycle, once for every edge transition on both input lines.

Table 4.3 Count Mode Settings

Mode	Channels	Bits	Function
UniDirectional	8	00	Unidirectional Up/Down counter
BiDirectional	4	01	Bidirectional Up/Down counter
Quad X1	4	10	Quadrature Mode 1 count/cycle
Quad X4	4	11	Quadrature Mode 4 counts/cycle

Stop on Zero: (Configuration Bit 8)

This bit, when set, will hold the counter output at zero. When the counter counts down to zero the counter will either count through zero or hold its output at zero counts, until the Zero flag is cleared. When cleared the counter will continue to count.

Note: The stop on zero function only applies to counts decrementing down through zero.

Stop on Limit: (Configuration Bit 9)

This bit, when set, will hold the counter output at its limit value. When the counter counts to the limit value it will either rollover to zero, or hold its output at the limit value, until the Limit Flag is cleared. When released the counter will continue to count. If the user defined limit register is equal to zero, the limit is internally set to 32,767 (Normal Mode) or 8,388,607 (Extended Mode).

Filter Frequency: (Configuration Bit 10)

This bit selects the cutoff frequency that the input channel will allow. When the bit is set to 1 the filter will be set to limit input noise to 30kHz. This selection should be used for Counter or Flow Meter applications running at speeds less than 30kHz. When this bit is set to 0 the channel will run at full speed and filter noise above 50kHz.

A 15kHz hardware filter is also available by using the onboard jumper settings. To activate the filter for Channels 0-3 remove the shunt on the JP2 jumper. To activate the filter for Channels 4-7 (CTR8 only) remove the shunt on JP3.

Count Size: (Configuration Bit 11)

This bit determines the maximum counter value. When set to 0 the channel counter will count up to $\pm 32\text{K}$ (1 word of data). When the maximum value of 32,767 is reached, the Maximum Count flag is set, and rollover will occur at this point. When the count size is extended to $\pm 8,388,607$ by setting this bit to 1, the Counters Maximum flag is extended to $\pm 8\text{M}$ and data output is formed using two words. The counter Preset and Limit values are also extended to $\pm 8\text{M}$. This means that the resolution of the Preset and Limit values are set in blocks of 256 counts (8bits) because only one word is available for each limit. This allows the preset and limit values to cover the whole $\pm 8\text{M}$ bit range.

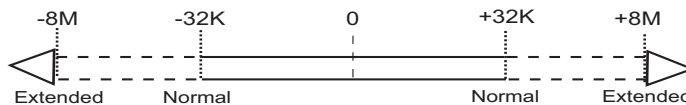
**Count Direction: (Configuration Bit 12)**

This bit inverts the current direction of the counter. When set to 0 this bit has no effect on the direction. When toggled to 1 the count direction in unidirectional mode is forced to count down. In bidirectional mode or Quadrature mode the counter direction is reversed from its current direction.

Counter Roll Over: (Configuration Bit 13)

When the counter exceeds the maximum count, the counter will roll over the top. When the counter rolls over it can roll over to a starting value of zero, or it can start at the user defined preset value. When this bit is set to 0 the counter will roll over to zero. When set to 1 the counter will roll over to the preset value. If the stop on limit flag is set the counter will not roll over until the flag is released. When released the counter will roll over to zero or its preset value.

Counter Roll Under: (Configuration Bit 14)

When the counter rolls under zero it can continue to count down into negative numbers, or it can start at the user defined preset value. When this bit is set to 0 the counter will continue to count down through zero into negative numbers. When set to 1 the counter will roll under to the preset value. If the stop on zero flag is set the counter will not roll under until the flag is released. When released the counter will roll under to its maximum or preset value.

Program Scale Factors: (Configuration Bit 15)

Each channel has four words which configure the behavior of that channel, the configuration word, the Preset / M factor word, the counter Limit / K factor word, and the Rate Limit / R Factor word. Normally the 2nd, 3rd and 4th words are Preset, Counter Limit, and Rate Limit respectively. However, when values are input into the scale factors and bit 15 of the configuration word is set the module programs the scale factors into non-volatile memory. When scale factors are programmed the R and K/M Factor Flags are set in the status register.

Output Register - Scale and Limit Data Values

When using the Counter Preset, Counter Limit, Rate Limit or K / M / R Factors you must input the value that is appropriate for your application. The values follow each channels configuration word and use the next three configuration words. For example, Channel 0 has a configuration word address of O:e.0, Preset address of O:e.1, a Counter Limit address of O:e.2, and a Rate Limit address of O:e.3. Refer to the Input word data diagram in the beginning of this chapter for channel specific address information.

Figure 4.5 - Preset / Limit / Rate Limit Words

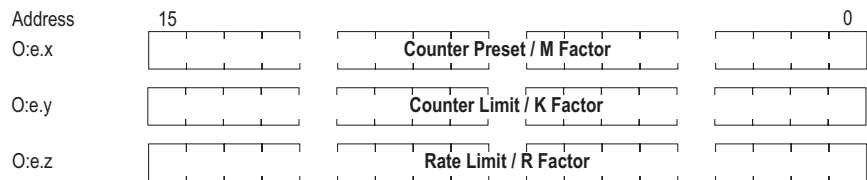

Counter Preset / M Factor:

The counter preset function is used in Normal operation mode. This input data word is used in conjunction with the scale/limit mode bit. When this bit is set, the value in the counter preset word is loaded into the counter. The counter preset can be used to set the counter to an initial starting value. The bit should be set for at least one I/O scan. The bit can be held on until the data in the counter data is verified to be equal to the preset value. The counter will hold the preset value until the counter preset bit is turned off. At this time normal counter functions will resume. The preset value is typically set less than the Counter limit value.

Note: In extended count mode (counts up to +/- 8M) the preset will be multiplied by 256 internally such that a user preset of 1000 will result in a preset of 25600. This allows the preset value to cover the whole +/- 8 million count range.

In program scale factor mode an M Factor is stored in the module's non-volatile memory. If an M Factor is defined (not zero) then the data value output for the counter value will be $COUNT \times (M \text{ Factor}/10,000)$. A value of zero must be written to the M Factor to disable this feature.

Figure 4.7 - Limit / M Factor Word

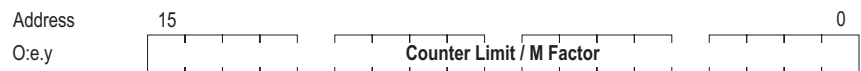

Example:

An M Factor of 10,200 will increase the output count by 2%.

$$\text{Output Count} = \text{Input Count} * 10,200/10,000$$

$$\text{Output Count} = \text{Input Count} * 1.02$$

Note: When the count size is extended to $\pm 8M$ using Configuration Bit 11, the Counters Maximum flag is extended to $\pm 8M$. The counter Preset and Limit values are also extended to $\pm 8M$. This means that the resolution of the Preset and Limit values are set in blocks of 256 counts (8bits). This allows the preset and limit values to cover the whole $\pm 8M$ bit range. Refer to the applications section of this manual for more information about setting limit and scale values.

Counter Limit / K Factor:

The counter limit mode is used in Normal operation mode. This input data word is used in conjunction with the Scale / Limit Mode enable bit. When the counter limit bit is set, the counter limit flag will be active. When the counter value is greater then or equal to the Limit value the Counter Limit flag bit will be set. If the Stop On Limit bit is set the counter will not exceed the counter limit.

Note: When operating in standard count mode, if the K Factor x Count Limit is > 32767 a configuration error will occur.

Note: In extended counter mode the limit will be multiplied by 256 internally such that a user limit of 1000 will result in a limit of 256,000.

In program scale factor mode a K factor is stored in the module's non-volatile memory. If a K Factor is defined (not zero) then the data value output for the counter is the counter value divided by the K Factor. A value of zero must be written to the K Factor to disable this feature.

Figure 4.6 - Preset / K Factor Word

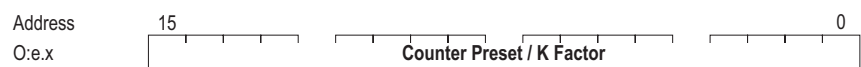

Rate Limit / R Factor:

The rate limit function is used in the Normal operation mode. The Rate Limit represents a target maximum value for rate. When the rate value is greater than or equal to the rate limit value the Rate Limit flag bit will be set.

In program scale factor mode an R Factor is stored in the module's non-volatile memory. If an R Factor is defined (not zero) then the data value output for the counter value will be Rate / R Factor. A zero value must be written to the R Factor to disable this feature.

Figure 4.8 - Rate Limit / R Factor Word

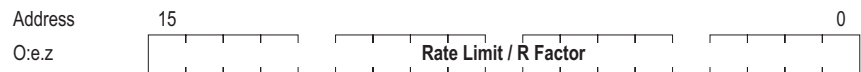

Refer to the applications section of the manual for limit and scale examples.

Floating Point Rate Mode is activated by setting the Rate Factor to -1. See Appendix A for information about the floating point mode.

Input Registers - Channel Data

The channel data consists of 4 words, the lower counter data value, the upper counter data value, the rate data value and the channel status data.

Table 4.4 - Data Word Addresses

CTR8	CTR4	Scale/Limit Value
l:e.0 to l:e.3	l:e.0 to l:e.3	0 Channel MSW, LSW, Rate Data, Status Reg
l:e.4 to l:e.7	l:e.4 to l:e.7	1 Channel MSW, LSW, Rate Data, Status Reg
l:e.8 to l:e.11	l:e.8 to l:e.11	2 Channel MSW, LSW, Rate Data, Status Reg
l:e.12 to l:e.15	l:e.12 to l:e.15	3 Channel MSW, LSW, Rate Data, Status Reg
l:e.16 to l:e.19	(n/a)	4 Channel MSW, LSW, Rate Data, Status Reg
l:e.20 to l:e.23	(n/a)	5 Channel MSW, LSW, Rate Data, Status Reg
l:e.24 to l:e.27	(n/a)	6 Channel MSW, LSW, Rate Data, Status Reg
l:e.28 to l:e.31	(n/a)	7 Channel MSW, LSW, Rate Data, Status Reg

Figure 4.9 - Data Words

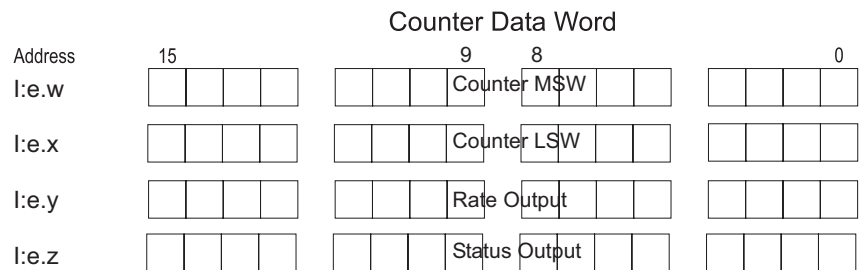

Counter Data, High word:

This input data register contains the upper word of the counters accumulator. This register is a 16 bit word in binary 2's complement format. When operating in the extended count mode, $\pm 8M$ counts, the high word is equal to the counter value/1,000 and the low word is the remainder. For example, a count of 40,123 would result in a high word equal to 40, and the low word equal to 123. The high word = 40 and the low word = 123.

Figure 4.10 -Counter High Word

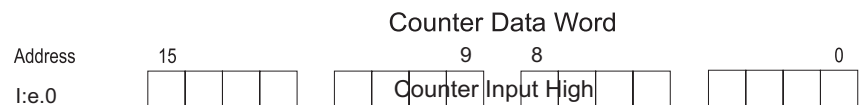

This register is always zero when operating the the standard (32k) count mode.

Counter Data, Low word:

This input data register contains the lower word of the counter accumulator. This register is a signed 16 bit word in binary 2’s complement format and will allow count values up to ±32K. This word is used in conjunction with the counter’s upper output word when in the extended count mode. Bit 15 represents the sign for each word. When the counter is operating in the extended mode, the low and high words are used together to form a composite number that extends the counter to ±8M. The low word represents counts up to 1000 and the high word represents counts that carry over 1000. (When the counter is configured in Extended mode.)

$$\text{Actual count} = (\text{Value of the high word} \times 1000) + (\text{Value of the low word}).$$

Figure 4.11 -Counter Low Word

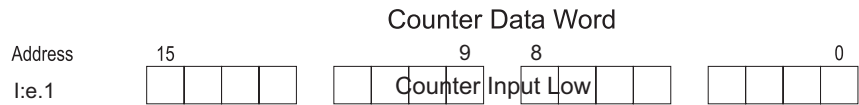

Rate Register word:

Refer to Appendix A for floating point rate mode.

This input data register contains the rate value while operating in rate mode. This register is a 16 bit word in binary 2’s complement format and represents the input value. Note that if the R Factor is present the output data value is represented as the Rate / R Factor. Rates greater than 32kHz must use a R factor otherwise overflow will occur. If the R factor is set to 2 and your input rate is 50kHz, the data output word will read 25,000.

Figure 4.12 -Counter Rate Word

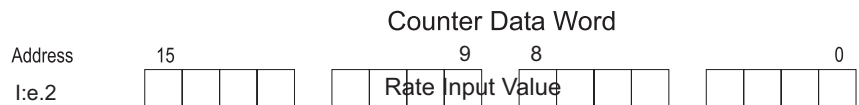

Check each input channel's configuration and status

Channel Status Flags

Figure 4.13 Channel Status Flags

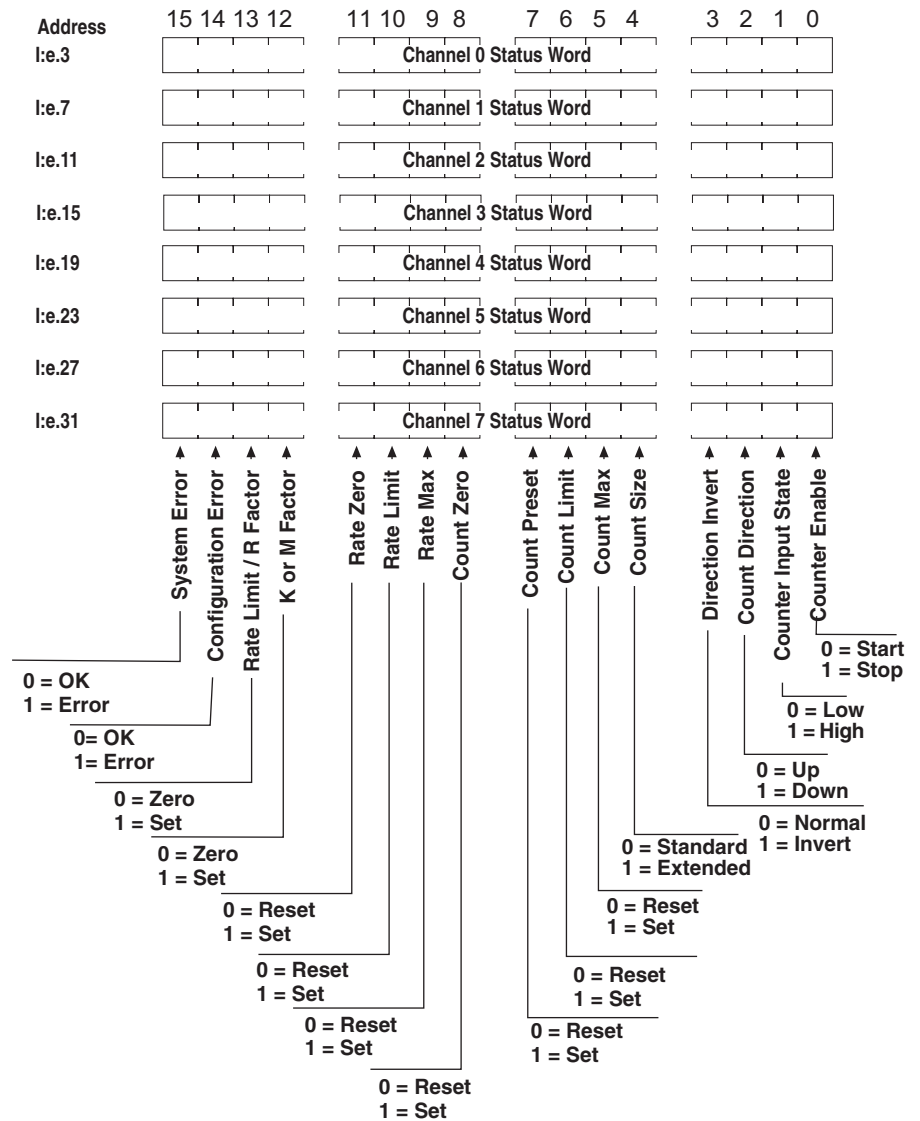

Counter Start/Stop Echo: (Status Bit 0)

This bit echo's the setting of the Counter Enable bit set in the channels control register. The counter enable bit allows the counter to continue to count up or down from its present value.

Counter Input State: (Status Bit 1)

This bit shows the current value of the input state. The state of the input will be sampled at the end of the current update cycle. For rapidly changing counter inputs the state of this bit could be either high or low depending on the exact time of measurement. The purpose for this bit is to provide slow counter feedback and single count diagnosis. This bit can also be used as a general purpose digital input line back to the PLC.

Counter Direction State: (Status Bit 2)

This bit shows the current direction of the counter. The state of the counter direction will be sampled at the end of the current update cycle. For rapidly changing counter inputs the state of this bit could be either high or low depending on the exact time of measurement. The purpose for this indicator is to provide quadrature detection feedback to aid in system diagnosis.

Count Direction Invert Bit echo: (Status Bit 3)

This bit echo's the state of the Count Direction bit set in the channel configuration register. The count direction status echo's the state of the invert bit. It does not determine if the count is going up or down.

Count Size Selection echo (Status Bit 4)

This bit echo's the state of the maximum counter value selected in the configuration register. When zero the channel counter is in standard mode and will count up to $\pm 32K$ (1 word of data). When set to 1 the is in the extended mode and will have a maximum value of 8M which is formed using the MSW and LSW data words..

Counter Max Flag: (Status Bit 5)

The flag is set when the maximum count, based on Normal or Extended mode, is reached. Refer to the Reset Flags, Configuration Bit 2, in the configuration word section of this chapter for a description of this flag's operation.

Counter Limit Flag: (Status Bit 6)

The flag is set when the user defined count limit is reached. Refer to the the configuration word section of this chapter for a description of this flag's operation.

Counter Preset Echo: (Status Bit 7)

The flag is echos the state of the preset bit on the configuration register.

Counter Zero Flag: (Status Bit 8)

The flag is set when the counter counts down through zero. Refer to the configuration word section of this chapter for a description of this flag's operation.

Max Rate Flag: (Configuration Bit 9)

The max rate flag is set when the input rate exceeds its maximum range of 32,767kHz. This flag indicates that the input counter rate is over the valid range of the module and that the value indicated in the rate data register may not be correct. This flag will stay on until the input rate falls below the rate limit. If a Rate R Factor of 2 or more is used the Max Rate Flag will be set at an input frequency of 50kHz

Rate Limit Flag: (Configuration Bit 10)

When the rate value is greater than or equal to the Rate Limit value the Rate Limit flag bit will be set. This flag will stay on until the input rate falls below the rate limit.

Rate Zero Flag: (Configuration Bit 11)

The rate zero flag is set when the input rate is zero. This flag can be used to flag an input fault condition. The rate zero flag is set when no input is detected for 2 seconds.

K Factor / M Factor Set Flag: (Configuration Bit 12)

This bit indicates that a non zero K or M factor value has been written to the module's non-volatile memory. This value will be use to scale the input counter data. When a K or M factor is set all count data will be scaled by the K or M factor data.

R Factor Set Flag: (Configuration Bit 13)

This bit indicates that a non zero R factor value has been written to the module's non-volatile memory. This R factor value is used to scale the rate data or enable the floating point rate mode.

Configuration Error Flag: (Configuration Bit 14)

This flag is set when the channel configuration word is set to an illegal state. An example would be if one channel was configured for quadrature detection and its quadrature pair was not. In this case both channels would have their configuration flags set until the configuration word was corrected. All counter data will be set to zero when an illegal configuration occurs.

System Error Flag: (Configuration Bit 15)

This flag is set when the module detects a system error. System Errors are reported when the module can't complete its power up self test or detects some other on line error, like a watchdog time out.

Programming / Application Examples

Learning to configure your counter to meet your application requirements will require knowledge of counter configuration, ladder logic programming and data management. Read this chapter to familiarize yourself with how to use the advanced features of your module for:

Sample Counter
Configuration

Simple Linear
Counter
(10,000 Limit):

This configuration for Channel 0 of the counter module will allow the user to count from zero to a maximum value of 10,000 counts.

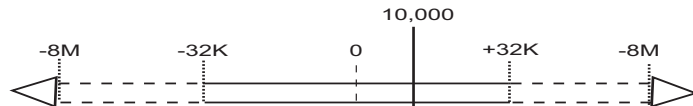

To facilitate this you must input a Limit of 10,000 counts. This cycle will continue, without stopping, with these configuration settings.

Channel 0 - Output Register Configuration (O:e.0)

Output Register Configuration

<i>Config. Bit</i>	<i>Description</i>	<i>Bit Setting</i>	<i>Description</i>
*15	Normal	0	Normal Mode
14	Roll Under	0	Roll to Neg. #s
13	Roll Over	0	Roll to Zero
12	Direction	0 (Default)	No Inversion
11	Count Size	0 (Default)	±32K Std.
10	Freq. Filter	0 (Default)	50kHz
9	Stop on Limit	0 (Default)	No Stop
8	Stop on Zero	0 (Default)	No Stop
6/7	Count Mode	00 (Default)	Unidirectional
4/5	Input Range	00 (Default)	50mV-30VAC
3	Rate. Mode	0 (Default)	Instant Mode
2	Reset Flags	0 (Default)	Off
1	Counter Preset	0 (Default)	Off

No scale factors or associated flags are used. The input range is based on your input signal type. The filter on the input rate defaulted to 50kHz.

Configuration Word

O:e.2 Counter Limit 10,000

We have set the limit to 10,000.

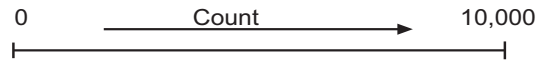

Note: If we change Configuration Bit 9 to 1 the counter will reach the limit and then hold its value until the Limit Flag is cleared. Then it will roll to 0, and continue counting to 10,000. Each time the limit is reached the flag must be reset before proceeding.

Note: If we toggle Configuration Bit 12 the counter counts in a downward direction. It will start at 0 and count to -32,768. It will then Roll Under to +32,767. If Configuration Bit 14 is set the counter will Roll Under to this Preset Value.

Ring Counter Sample

The figure below demonstrates a ring counter operation. In a ring counter operation, the count value changes between zero and maximum. If, when counting up, the counter reaches the maximum value, it rolls over to zero. If, when counting down, the counter reaches zero, it rolls under to the maximum value.

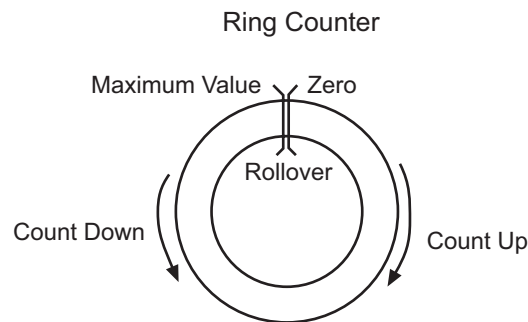

Sample Configuration Simple Ring Counter w/ Flags (20k Limit):

This configuration for the counter module will allow the user to count from a minimum value of 0 to a limit value of 20,000 counts. Each time a revolution has occurred the counter limit flag will be set. Your ladder program may use this flag to increment an accumulator, thus counting revolutions. The flag must be reset before another complete revolution occurs otherwise the accumulator can not be incremented.

Channel 0 Output Register Configuration (O:e.0)

<i>Config. Bit</i>	<i>Description</i>	<i>Bit Setting</i>	<i>Description</i>
*15	Normal	0	Normal Mode
14	Roll Under	1	Preset
13	Roll Over	0	Roll to Zero
12	Direction	0 (Default)	No Inversion
11	Count Size	0 (Default)	±32K
10	Freq. Filter	0 (Default)	50kHz
9	Stop on Limit	0	No Stop
8	Stop on Zero	0 (Default)	N/A
6/7	Count Mode	00 (Default)	Uni-Directional
4/5	Input Range	00 (Default)	50mV-30VAC
3	Rate Mode	0 (Default)	Instant
2	Reset Flags	0 (Default)	Toggle each Rev.
1	Counter Preset	0 (Default)	Off

Output Word - O:e.1 Counter Preset= 20,000

Output Word - O:e.2 Counter Limit = 20,000

A ring counter is configured by setting the preset and limit values to the same count and setting the roll over to zero and roll under to preset bits. Zero must always be the starting point and the maximum value must always be positive.

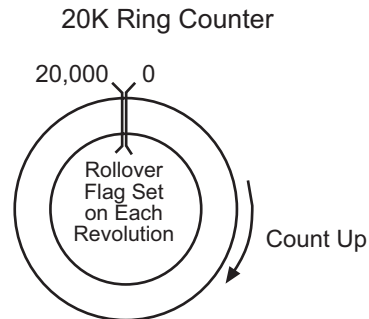

The above figure illustrates counting in a clockwise direction.

Using Preset Values with Extended Mode

The Counter Preset and Counter Limit functions are affected by the Count Size Configuration Bit 11. The default counter range is $\pm 32\text{K}$ but may be extended to $\pm 8\text{M}$.

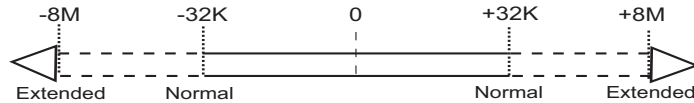

When operating in the extended range, $\pm 8\text{M}$, all Counter Preset and Counter Limit are multiplied by 256. The resolution of the Preset and Limit values in the standard mode is one count. The resolution in the extended mode is 256 counts.

Count Size	$\pm 32\text{K}$	$\pm 8\text{M}$	Description
Preset Value	1000	256,000	$= 1000 \times 256$
Limit Value	100	2560	$= 100 \times 256$

Using Scaling with Count and Rate Outputs:

Count Output:

Counter output scaling is applied using the K & M scale factors. When a scale factor is applied to the counter the Counter Output Register = (Raw Count * (M factor / 10000) * 1 / K Factor). When a scale factor is being used the Preset and Limit flags are also scaled.

Rate Output:

Rate output scaling is applied using the R scale factors. When a scale factor is applied to the module the Rate Output Register = Incoming frequency / R Factor. When a scale factor is being used the Rate Limit flag is also scaled.

Example:

As an example if a rate factor of $R = 2$ is programmed into the module.

The Rate Limit value is set to 10KHz

In this example the Rate Limit Flag would be set when the input frequency is $\geq 20\text{KHz}$.

Rate Limit Flag = Input Frequency * R factor

$$\text{Rate Limit Flag} = 10,000\text{Hz} * 2 = 20,000\text{Hz}$$

Application: Meter Proving

The 1746sc-CTR4/8 module provides a feature that allows the user to perform meter proving functions. A typical meter proving application would include two detector sensors that are located a fixed distance from each other within a section of pipe used specifically for meter proving. The operation does not disrupt the in situ flowmeter's operation.

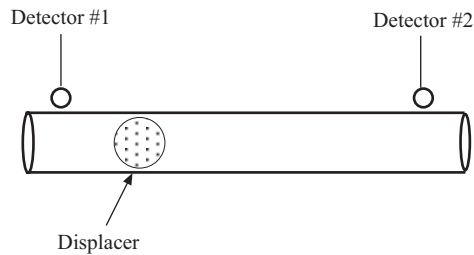

Utilizing the external gate enable to start and stop count functions enables the user to count pulses as fast as 20 microseconds to an accuracy of 1 count.

Here is an example wave form representing the start and stop transitions on the external gate enable, and the associated pulses that the module would accumulate:

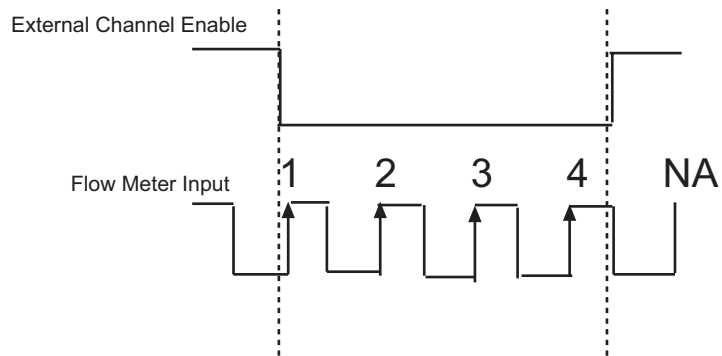

Given the above wave form, the module will begin counting the first positive going input pulse after the external enable input goes low. The module will accumulate 4 counts in the channel count register and stop when the external enable input goes high.

The external enable line accommodates 5 Vdc, 12 Vdc and 24 Vdc signals and is pulled low internally. The counter input accommodates 5 Vdc, 12 Vdc, 24 Vdc and up to 75 Vac inputs.

Application Note: Factor Data Errors

The 1746sc-CTR4/8 module provides a feature that allows the user to load M, K and Rate factor values into module memory without consuming additional control registers. In order to accommodate this feature into the design, three of the four registers assigned to each channel of the module are multiplexed with the Counter Preset, Limit and Rate limit values.

If factored data values are inadvertently loaded into the module without user knowledge of this occurring, the module can appear to be non functional.

Follow these steps to identify if factored data values have been loaded and if so, how to clear those values to return the module to default operation.

Use Channel Status registers to identify the presence of Factored Data values

Use Bits 12 and 13 in the channel status registers to verify if factored data is present. If either or both of the bits are set to a one the module has factor data values loaded.

Here are the address for the channel status registers:

<u>Channel</u>	<u>Register</u>
<u>0</u>	<u>I:e.3</u> (Where <u>e</u> indicates slot where module is installed)
<u>1</u>	<u>I:e.7</u>
<u>2</u>	<u>I:e.11</u>
<u>3</u>	<u>I:e.15</u>

CTR8 only:

<u>4</u>	<u>I:e.19</u>
<u>5</u>	<u>I:e.23</u>
<u>6</u>	<u>I:e.27</u>
<u>7</u>	<u>I:e.31</u>

Clear loaded factor data

In order to clear the factored data 0 must be loaded into the Preset / K Factor, Limit / M Factor and Limit / R Factor registers. **After entering 0 into these registers bit 15 of the module Configuration register must be toggled from 0 to 1 and then back to 0.**

There are 4 registers assigned for each Channels output configuration word. The first register assigned is the channel configuration register. The next 3 registers are the Preset / K Factor, Limit / M Factor and Limit / R Factor registers respectively.

Refer to Page 24 for detailed information regarding the output configuration registers and their functions.

Testing Your Module

Read this chapter to prevent potential problems in a systematic and controlled way. This chapter covers:

- inspecting your module
- disconnecting prime movers
- powering up
- interpreting the LED indicators
- interpreting I/O error codes
- troubleshooting

Before testing your module, test your SLC 500 system using the procedures described in your system's *Installation & Operation Manual*.

Inspecting Your Module

You can prevent many potential problems by simply inspecting your analog module:

1. Ensure that all wire connections are correct and secure and that no wires are missing or broken.



CAUTION

FIELD WIRING ERRORS

Before enabling a channel (through your ladder program), ensure that you have chosen a proper input range for your input signal.

Failure to observe this precaution can cause improper module operation or equipment damage.

2. Ensure that the shield for the cable used to wire your module is properly grounded. Refer to Chapter 2, *Installing And Wiring Your Module*, for more information.
3. Ensure that the removable terminal block on your module is secure.

Disconnecting Prime Movers

Before testing your module, ensure that machine motion will not occur:

- Disconnect motor wires at the motor starter or the motor itself. This lets you test the operation of the starter coil, verifying that the output circuit is wired correctly and functioning.
- Disconnect solenoids by disengaging the solenoid valves, leaving the coils connected.

If you cannot disconnect a device in the preferred way, open the output circuit as close as possible to the motion-causing device.

Example – If you have a relay coil that in turn energizes a motor starter and you cannot disconnect the motor wires, open the circuit at a point between the motor starter and the relay contact.



WARNING

POSSIBLE UNEXPECTED MACHINE MOTION

During all testing, always disconnect all devices that, when energized, might cause machine motion.

Failure to observe this precaution can cause equipment damage or personal injury.

Powering Up

When you apply power to the system, the module status LED should illuminate, indicating that your module is receiving power and has completed its onboard self-test. If the LED does not illuminate after several seconds, your module is not functional. Discontinue testing until you can get the LED to illuminate.

The most probable reasons for the LED not illuminating are:

- The SLC 500 system is not receiving power from its power supply.
- The rack slot where your module is located is defective.
- Your module is defective.

Interpreting The LED Indicators

Your module has nine LEDs: eight channel status LEDs (numbered 0–7 for channels 0–7, respectively) and one module status LED.

Figure 6.1. LED block

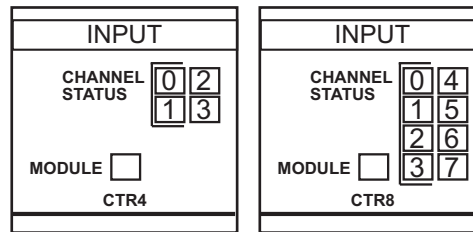

Operation

The module has 9 (5-CTR4) LED's that indicate the following...

Module Status LED: 1 Green LED Indicates that the module has completed its self test and is ready. Module and self test errors are reported by an error blink code.

Channel Status LED's: 8 Green LEDs The channel status LED's indicate that the given channel is Enabled. See table below for blink code.

The Module and Channel Status LEDs produce diagnostic blink codes when an error occurs. If the Module Status LED produces a blink code, please contact your local AB Representative or one of our technical support engineers

The Channel Status LED error codes may be used to detect channel configuration errors.

Table 6.1 Channel Status LED Blink Codes

Blink #	Fault
1	Frequency Scale / F Factor Out of Range
2	Frequency Input Range Mismatch Channel pairs, 0-1 / 2-3 / 4-5 / 6-7 must be configured for the same range.
3	Bidirectional or Quadrature Mode Configuration Error Channel pair configuration word must be identical for these modes.
4	Negative K, M, or F Factor.
5	Limit out of range.
6	Preset out of range.
7	High resolution rate and 24 bit counter mode set.

Codes

I/O error codes appear in word S:6 of the SLC processor status file. The first two digits of the error code identify the slot (in hexadecimal) with the error. The last two digits identify the I/O error code (in hexadecimal).

The error codes that apply to your module include (in hexadecimal):

- 50–5E
- 71 (watchdog error)
- 90–94

For a description of the error codes, refer to the *Allen-Bradley Advanced Programming Software (APS) Reference Manual*, Allen-Bradley publication 1746-6.11.

No Signal

After reviewing your configuration and LEDs for errors you may want to check the input register Rate word for any indication of signal. If status bit 1 (Counter Input State) is high and status bit 11 (Rate Zero) is high you may require a 1 to 10k Ω pull-down resistor (depending on the in-put device) between your channel input and channel common.

If you have an open collector output or a relay or contact type output you may need the pull-down resistor. Refer to your sensor documentation for additional information.

Verify that your input level thresholds are matched to your configuration word input range.

Troubleshooting

Figure 6.2. Problem resolution flowchart

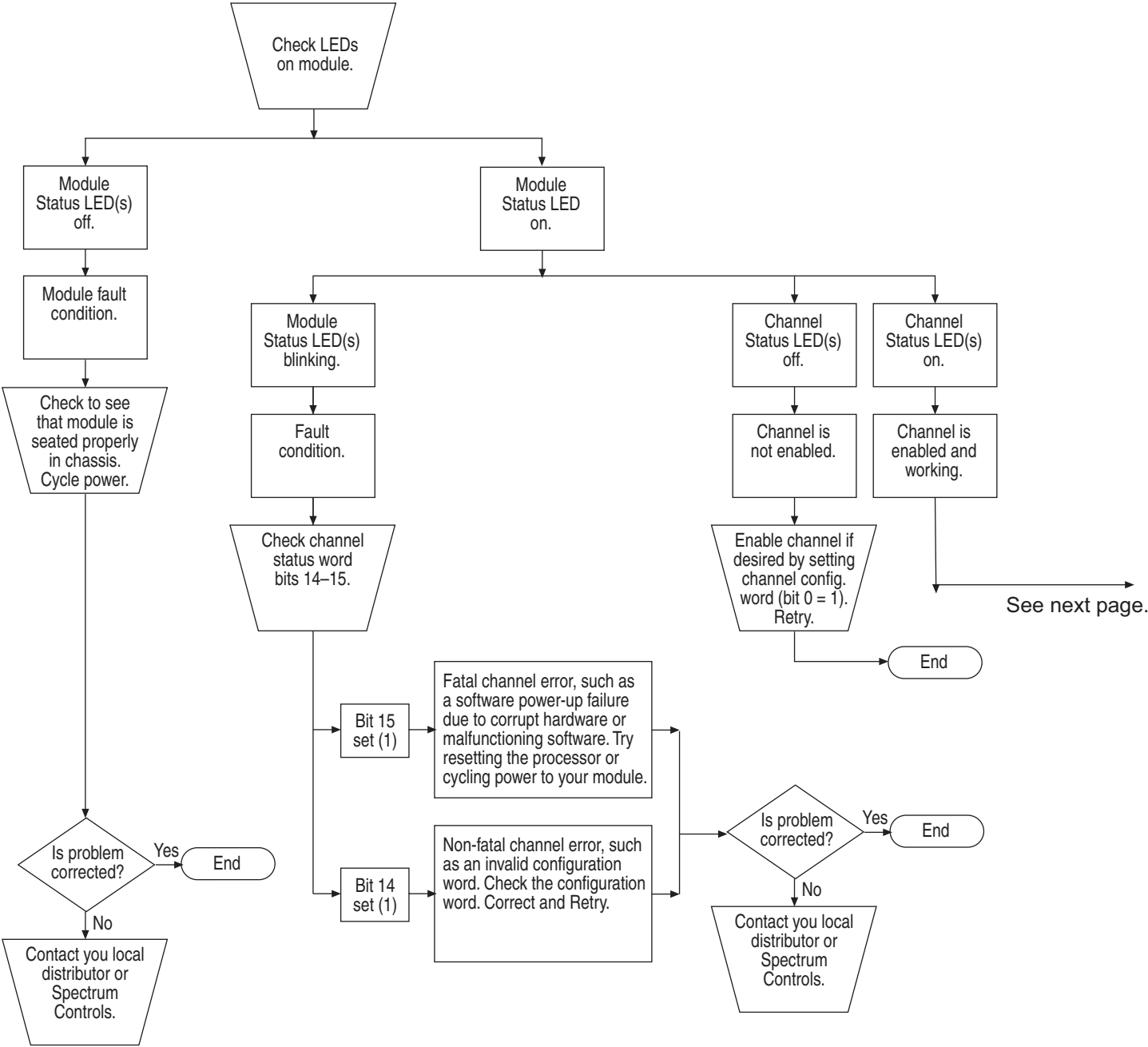

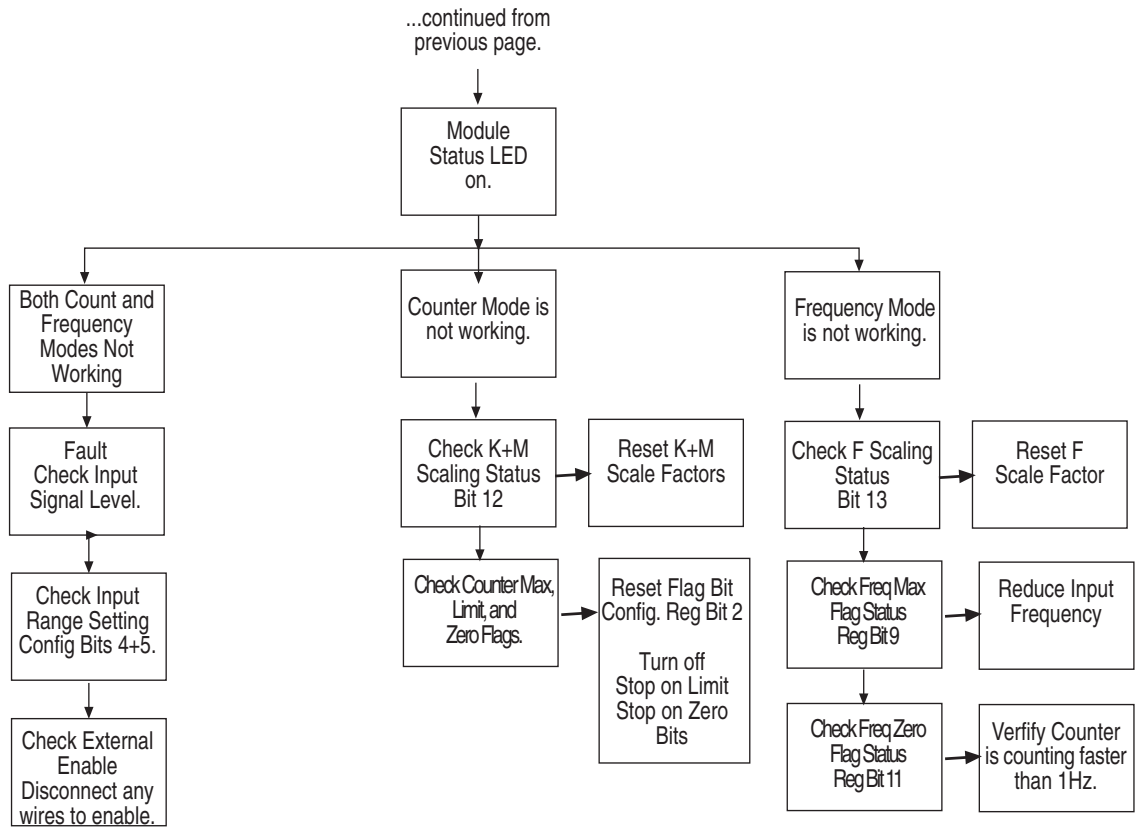

Maintaining Your Module And Ensuring Safety

Read this chapter to familiarize yourself with:

- preventive maintenance
- safety considerations

The National Fire Protection Association (NFPA) recommends maintenance procedures for electrical equipment. Refer to article 70B of the NFPA for general safety-related work practices.

Preventive Maintenance

The printed circuit boards of your module must be protected from dirt, oil, moisture, and other airborne contaminants. To protect these boards, install the SLC 500 system in an enclosure suitable for its operating environment. Keep the interior of the enclosure clean, and whenever possible, keep the enclosure door closed.

Also, regularly inspect the terminal connections for tightness. Loose connections may cause a malfunctioning of the SLC system or damage to the components.



WARNING

POSSIBLE LOOSE CONNECTIONS

Before inspecting connections, always ensure that incoming power is OFF.

Failure to observe this precaution can cause personal injury and equipment damage.

Safety Considerations

Safety is always the most important consideration. Actively think about the safety of yourself and others, as well as the condition of your equipment. The following are some things to consider:

Indicator Lights – When the module status LED on your module is illuminated, your module is receiving power.

Activating Devices When Troubleshooting – Never reach into a machine to activate a device; the machine may move unexpectedly. Use a wooden stick.

Standing Clear Of Machinery – When troubleshooting a problem with any SLC 500 system, have all personnel remain clear of machinery. The problem may be intermittent, and the machine may move unexpectedly. Have someone ready to operate an emergency stop switch.



CAUTION

POSSIBLE EQUIPMENT OPERATION

Never reach into a machine to actuate a switch. Also, remove all electrical power at the main power disconnect switches before checking electrical connections or inputs/outputs causing machine motion.

Failure to observe these precautions can cause personal injury or equipment damage.

Safety Circuits – Circuits installed on machinery for safety reasons (like over-travel limit switches, stop push-buttons, and interlocks) should always be hard-wired to the master control relay. These circuits should also be wired in series so that when any one circuit opens, the master control relay is de-energized, thereby removing power. Never modify these circuits to defeat their function. Serious injury or equipment damage may result.

Refer to your system's *Installation & Operation Manual* for more information.

Floating Point Rate Mode

Read this appendix to:

- configure rate for floating point mode
- read input words to get data
- use ladder logic to create floating point value

Overview

The floating point rate mode allows the user to monitor rate to a higher degree of accuracy. The default mode for the counter module provides 1Hz rate resolution. The floating point mode allows the module to report rate resolution of up to 0.0001Hz. The rate resolution is dependent on the input signal speed. Low speed signals will provide the highest resolution. As rate increases the frequency accuracy will decrease.

Configuring Each Input Channel for Floating Point Rate

The Data Register format for floating point is different than the default register mode. The data words have been moved to accommodate the floating point rate value. Your ladder logic must be modified to support this new word format. In order to activate the floating point mode you must set the Rate Factor to a value of -1.

The following steps are necessary to accomplish this:

- 1 Load the value (-1) into the Rate Limit / R Factor
- 2 Toggle the Program Scale Factors configuration bit (Bit 15) to write the configuration to the module.
- 3 Clear the Program Scale Factors configuration bit (Bit 15).
- 4 Clear Rate Limit / R Factor Value
- 5 Create ladder logic to join the two input words to create your floating point value.

Input Registers - Channel Data

The channel data consists of 4 words, the lower counter data value, the rate data high value, the rate data low value and the channel status data.

Table A.1 - Data Word Addresses

CTR8	CTR4	Scale/Limit Value
I.e.0 to I.e.3	I.e.0 to I.e.3	0 Channel LSW, Rate Data High, Rate Data Low, Status Reg
I.e.4 to I.e.7	I.e.4 to I.e.7	1 Channel LSW, Rate Data High, Rate Data Low, Status Reg
I.e.8 to I.e.11	I.e.8 to I.e.11	2 Channel LSW, Rate Data High, Rate Data Low, Status Reg
I.e.12 to I.e.15	I.e.12 to I.e.15	3 Channel LSW, Rate Data High, Rate Data Low, Status Reg
I.e.16 to I.e.19	(n/a)	4 Channel LSW, Rate Data High, Rate Data Low, Status Reg
I.e.20 to I.e.23	(n/a)	5 Channel LSW, Rate Data High, Rate Data Low, Status Reg
I.e.24 to I.e.27	(n/a)	6 Channel LSW, Rate Data High, Rate Data Low, Status Reg
I.e.28 to I.e.31	(n/a)	7 Channel LSW, Rate Data High, Rate Data Low, Status Reg

Figure A.2 - Data Words

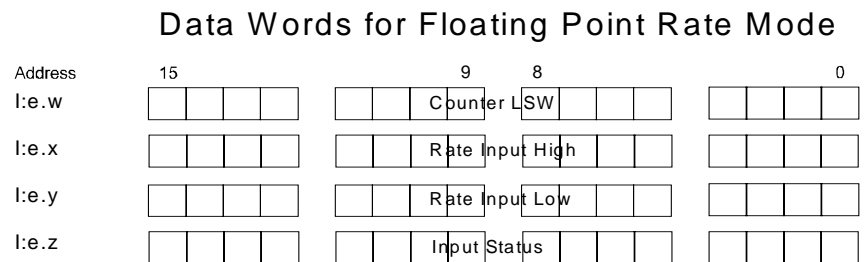

Setting the Rate Limit / R Factor:

The R Factor function is used to activate the floating point mode. Setting the value to -1 activates this mode. Use Bit 15 in your channel configuration word to save the R factor in the modules non-volatile memory.

Figure A.3 - Rate Limit / R Factor Word

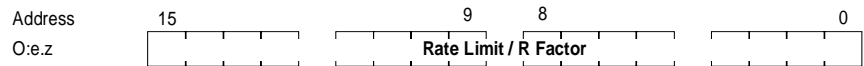

**Input Registers:
Channel Data**

Counter Register, Low word:

This input data register contains the lower word of the counter accumulator. This register is a signed 16 bit word in binary 2's complement format and will allow count values up to $\pm 32K$. This word is used in conjunction with the counter's upper output word when in the extended count mode. Bit 15 represents the sign for each word.



Note: Extended count mode is not a valid configuration when using the floating point rate mode.

Figure 4.10 -Counter Low Word

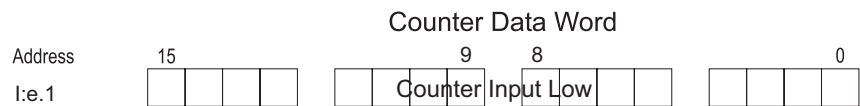

Rate Register words:

These two input data registers contain the rate value while operating in floating point rate mode. The registers represent a 32 bit word in binary 2's complement format and when combined form the 32 bit floating point rate value.

Figure 4.12 -Counter Rate Word

Data Words for Floating Point Rate Mode

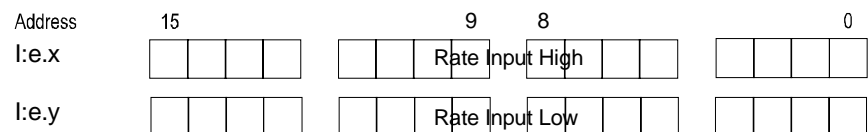

Module status:

Status remains the same as other modes. Information may be found in Chapter 4.

Ladder Logic

In order to create the floating point value it necessary to join the high and low rate data words. This is accomplished using the following ladder logic.

This rung converts the double word floating point value from the card to a floating point register within the ladder program.

COP	
Copy File	
Source	#1:1.1
Dest	#F8:0
Length	1

Getting Technical Assistance

If you need technical assistance, please review the information in Chapter 6, “Testing Your Module,” before calling your local distributor of Spectrum Controls.

Note that your module contains electronic components which are susceptible to damage from electrostatic discharge (ESD). An electrostatic charge can accumulate on the surface of ordinary plastic wrapping or cushioning material. **In the unlikely event that the module should need to be returned to Spectrum Controls, please ensure that the unit is enclosed in approved ESD packaging (such as static-shielding / metallized bag or black conductive container).** Spectrum Controls reserves the right to void the warranty on any unit that is improperly packaged for shipment.

For further information or assistance, please contact your local distributor or call Spectrum Controls Customer Support:

USA 440-646-6900

United Kingdom 01908 635230

Australia 1800-809-929

Brazil (55) 11 3618 8800

Europe (49) 2104 960 630

Declaration of Conformity

Available upon request.



The ENCOMPASS logo and SLC 500 are trademarks of Allen-Bradley Company, Inc. Copyright © 2000-2007, Spectrum Controls, Inc. All rights reserved. Printed in U.S.A. Specifications subject to change without notice. Publication 0300181-06 Rev. H February 2007

U.S.A. Headquarters
Spectrum Controls Inc.
P.O. Box 5533
Bellevue, WA 98006
Fax: (425) 641-9473
Tel: (425) 746-9481

Web Site: <http://www.spectrumcontrols.com>
E-mail: spectrum@spectrumcontrols.com

